

PRODUCT SHEET



VERSIONS



Round
• 3m/9'10"



Square
• 2.5m/8'2"

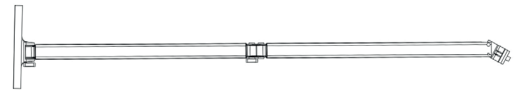

PARAFLEX® EVOLUTION HOLDER
Arm Length
• 2m/6'7"

POSITIONS



COLORS

	Alba	Roma	Taupe	Stonegrey	Mandarine	Red	Terra	Sunflower	Camel	Mint	Nero
PREMIUM											
LIMITED											
	Canvas	Taupe	Granite	Orange	Paris Red	Pink	Lagoon	Olive			

DIMENSIONS

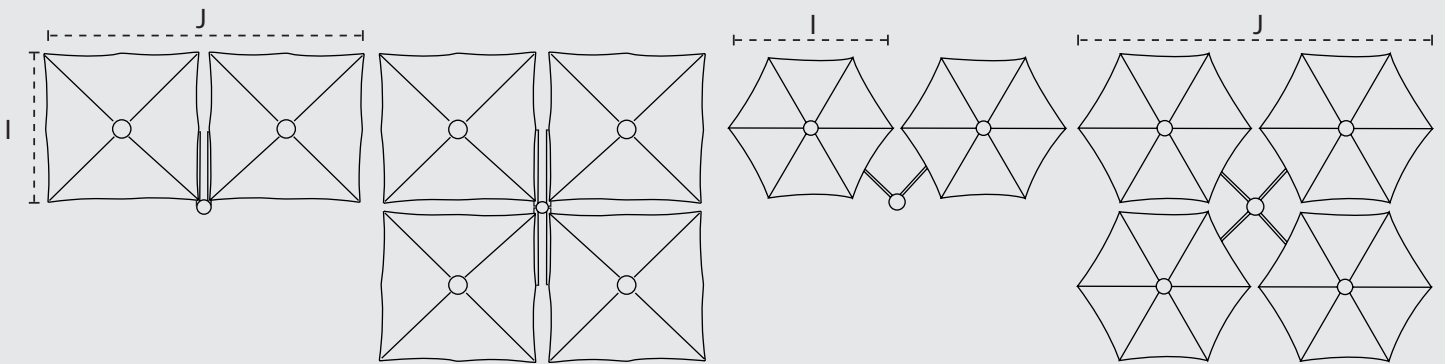
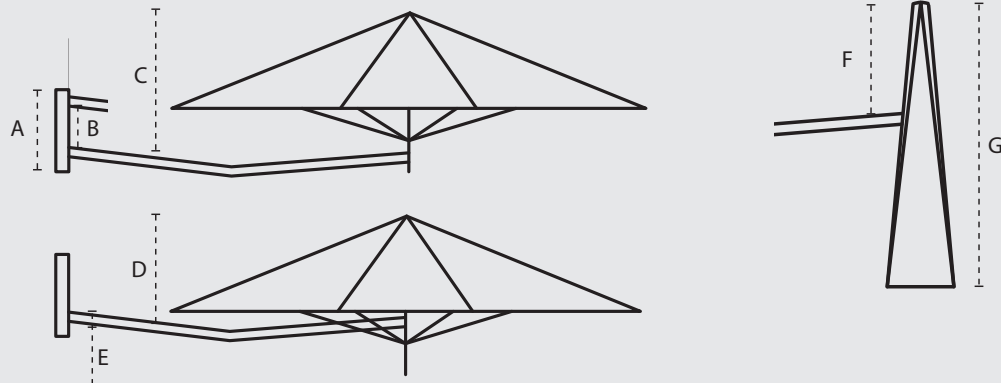

	A	B	C	D	E	F	G	I	J
	cm/inch	cm/inch	cm/ft	cm/ft	cm/inch	cm/ft	cm/ft	cm/ft	cm/ft
□ 2,5m	34/13,4"	19/7,5"	70/2' 3,5"	30/1'	6/2,4"	30/1'	193/6'4"	250/8' 2"	500/16' 5"
○ 3m	34/13,4"	19/7,5"	70/2' 3,5"	30/1'	6/2,4"	30/1'	165/5'5"	300/9'10"	600/19'8"

DIMENSIONS AND MATERIALS FOR SPIGOT BASES AND POLES

Spigot

Monoflex

Multiflex

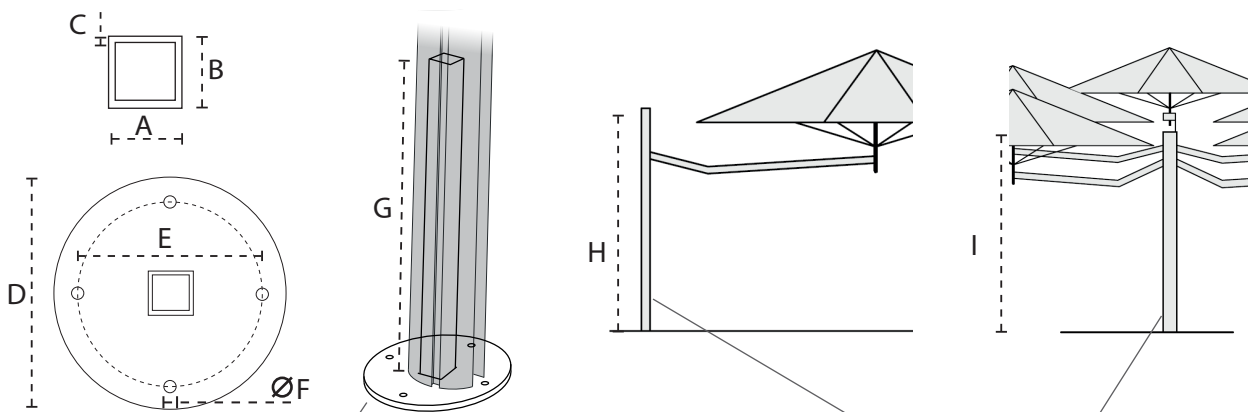

Galvanised steel 8mm/0.3"

Extruded Aluminium Alloy 6060, naturally anodised

	A	B	C	D	E	F	G	H	I
	mm/inch	mm/inch	mm/inch	mm/inch	mm/inch	mm/inch	mm/inch	cm/ft	cm/ft
Spigot Dimensions	40/1.6"	40/1.6"	3/0.12"	215/8.5"	170/6.7"	11/0.43"	490/19"	205/6'9" or 215/7"	230/7'6"

MATERIALS

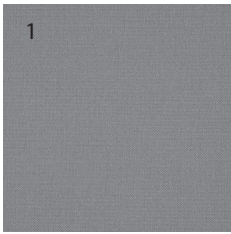

Fabric

- 'Premium': Olefine 190 g/m²
- 'Limited': 100% Sunbrella Acryl 270 g/m²
- For more detailed info, see spec Fabric

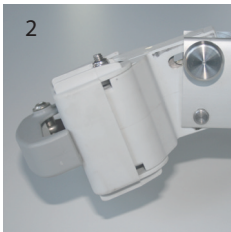

Polyamide

- PA6, 30% glass fiber

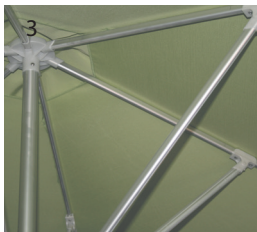

Aluminium profiles and clamp

- Aluminium Alloy 6060
- Naturally anodized

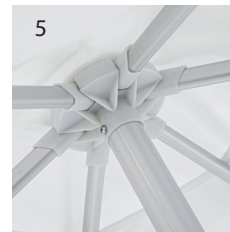
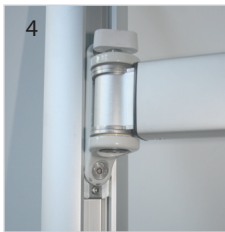

Polyamide

- PA6



Gear plates of stainless Steel

- Alloy AISI 304

Hinge of PA

- PA6, 30% glass fiber

BASE / FIXATION OPTIONS

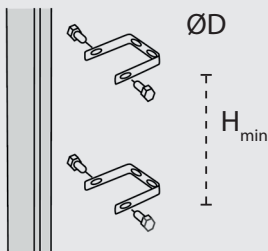

H _{min}	D	Weight
100 cm	10 mm	n/a
3'3"	0.4"	n/a

- Wall fixation
- Stainless steel 304

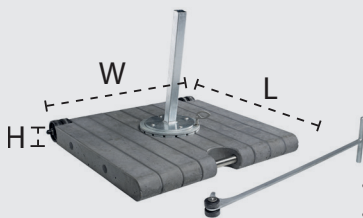

L	W	H	Weight
80 cm	80 cm	8.5 cm	120 kg
32"	32"	3.4"	265 lb

- High quality surface finish
- Demountable for easy transport
- Easy manipulation with handle

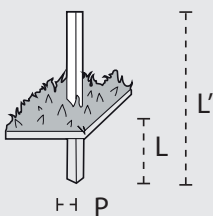

L	L'	P	Weight
40 cm	90 cm	40x40x3 mm	n/a
14"		1.6"x1.6"x0.12"	n/a

- Galvanised Steel
- Pit of 60x60x40cm or 2"x2"x1'4" filled with concrete

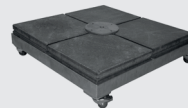

L	W	H*	Weight
85 cm	85 cm	15 cm	190 kg
34"	34"	6"	420 lb

* excl. wheels

TILE BASE

- Galvanised steel
- Fill with 12 tiles 40x40x4cm or or 12 tiles 16"x16"x2"

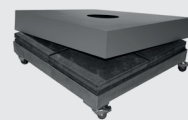

L	W	H	Weight
85 cm	85 cm	12,3 cm	10 kg
34"	34"	5"	25 lb

ALU COVER - optional

- Anodized aluminium plate 3mm

Dimensions and weight of cover only

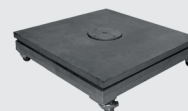

L	W	H	Weight
85 cm	85 cm	4 cm	70 kg
34"	34"	1,5"	155 lb

DECORATIVE COVER PLATE IN BLUESTONE - optional

Dimensions and weight of cover only

- Exclusive finishing: real Belgian bluestone
- Extra weight of 70kg



H	Weight
6,5 cm	2 kg
2,5"	5 lb

4 SWIVELING WHEELS - optional

PACKAGING & TRANSPORT

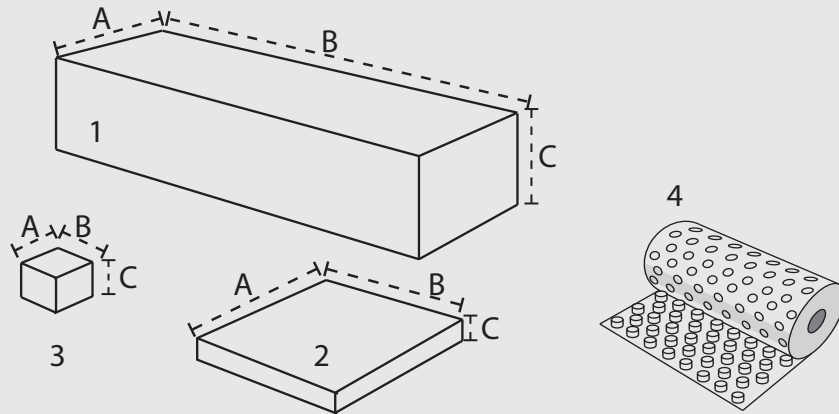

	Qty #	Type	A cm/ft,inch	B cm/ft,inch	C cm/ft,inch	Net weight kg/lb	Brut weight kg/lb
Box for arm 1.85m/6'1"	1	1	19/7.5"	113/3'8,5"	19/7,5"	0,6/1,3	5,0/11
Multipole Box	1	1	13/5"	235/7'8,5"	13/5"	0,70/1,54	9/20
Monoflex Box 205	1	1	11/4.3"	212/6'11.5"	10/4"	0,54/1.2	5.6/12
Monoflex Box 215	1	1	11/4.3"	222/7'3"	10/4"	0,54/1.2	5.6/12
In-Ground Fitting Package	1	4	15/15.9"	87/2'10.3"	5/2"	n/a	4/8.8
Wall Bracket Box	1	2	16/6.3"	16/6.3"	5/2"	0,04/0.09	0,63/1.4
Mobile Base Boxes	1	2	29/11.4"	85/2'9.5"	9/3.5"	0,63/1.4	6,0/13
	3	2	29/11.4"	85/2'9.5"	9/3.5"	0,63/1.4	40/88
Tile Base Box	1	2	86/2'10	86/2'10"	13/5"	0,59/1.3	10/23
Alu top Box	1	2	87/2'10.3"	87/2'10.3"	14/5.5"	1.2/2.65	10/22

NICE TO KNOW

- All parts can be ordered separately
- Designed and made in Belgium
- 2 years on decoloration of Premium fabric / 3 years on Limited
- 2 years warranty on structure
- For more info check: www.umbrosa.com
www.youtube.com/UmbrosalInnovation
www.facebook.com/Umbrosa

As a guideline we refer to the following wind speeds
 6 beaufort, 50km/h, 31 mph.
 Base is permanently fixed.

Tested at **TU Delft**



Umbrella includes:

Manual



Optional:



Storage Bag

- PU coated fabric
- Easy to use thanks to zipper and auxiliary tool



Heirweg 198A, 8800 Roeselare, Belgium.

T: +32 51 30.22.60 | F: +32 51 30.22.62 | E: info@umbrosa.com

The content of this document, in particular the mentioned models, is protected by copyrights and/or design rights. The present document and its content is communicated to you for information purposes only. Any partial or total reproduction or any other use without our prior written permission is strictly prohibited. This technical sheet remains subject to possible changes. Of course we do our best to eliminate all mistakes, but Umbrosa is not responsible for the errors in the documentation of products. All measurements are approximate and are provided for informational purposes only.